

Owners Manual



Introduction

Congratulations on your choice of the Geckplex EP-5!

The development of the Geckplex took many years. Throughout this process was a constant dedication to create a pedal that maintained the sound and feel of a vintage tape delay machine, while also providing a touch of the modern.

The monochrome artwork nods at the aesthetics of decades past, while nothing exemplifies the strive to preserve a vintage tape experience more than the delay slider. Several 1960's-1970's era machines set the delay time with a linear slide control that physically moved a tape head along a length of moving tape. The Geckplex now brings back that same slide control format to a modern device.

As far as the sound, everything possible was done to accurately simulate the unique sonic characteristics of analog tape machines. The echoes are nicely compressed, just as they would be due to the effects of tape saturation. The warp control allows adding in varying amounts of tape elements that cause echoes to degrade and “bloom” as they would with a more worn-in machine. Finally, an analog preamp gain stage provides the signal boost and power to drive amps with clarity, just as some older tape delays are well known for.

On top of the vintage sound and feel, the Geckplex is also imbued with some more modern features. To name a few, it comes complete with a tap-tempo with selectable subdivisions, fully programmable presets, expression pedal support, Sound on Sound looping, and separate wet and dry outputs, all packed in behind a simple and easy to use interface.

To ensure the highest quality, each Geckplex is manufactured, tested, and individually numbered by hand in Eugene, Oregon, USA. This commitment to quality additionally extends to the end-user experience. We truly hope you enjoy your Geckplex as much as we did creating it, and that it serves you well for years to come. However, if for any reason you aren't completely happy with it, we want to hear about it. If you totally love it, we don't mind hearing that either.

Sincerely,



Riley McNiff

Gecko Pedals Founder, Designer, Builder

Top Panel

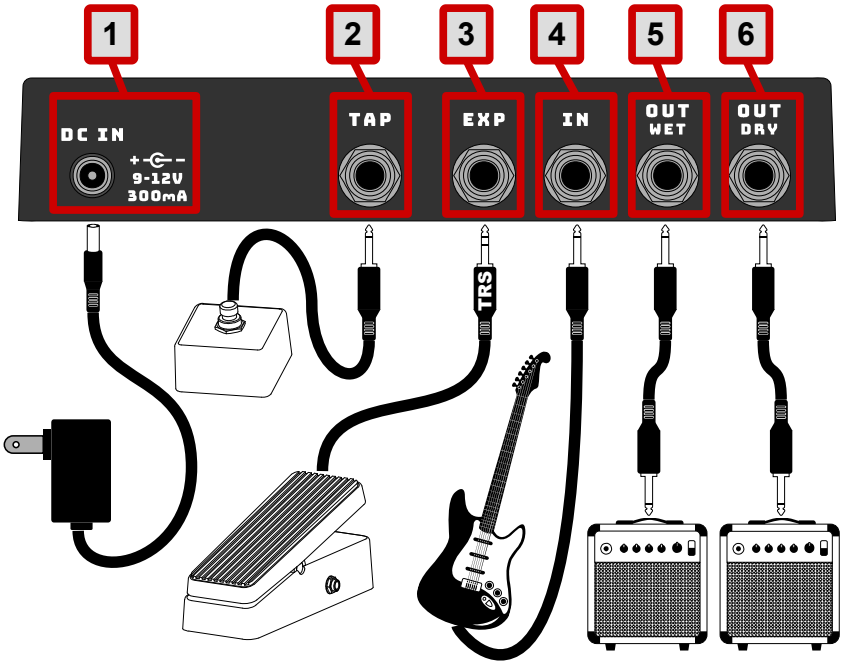





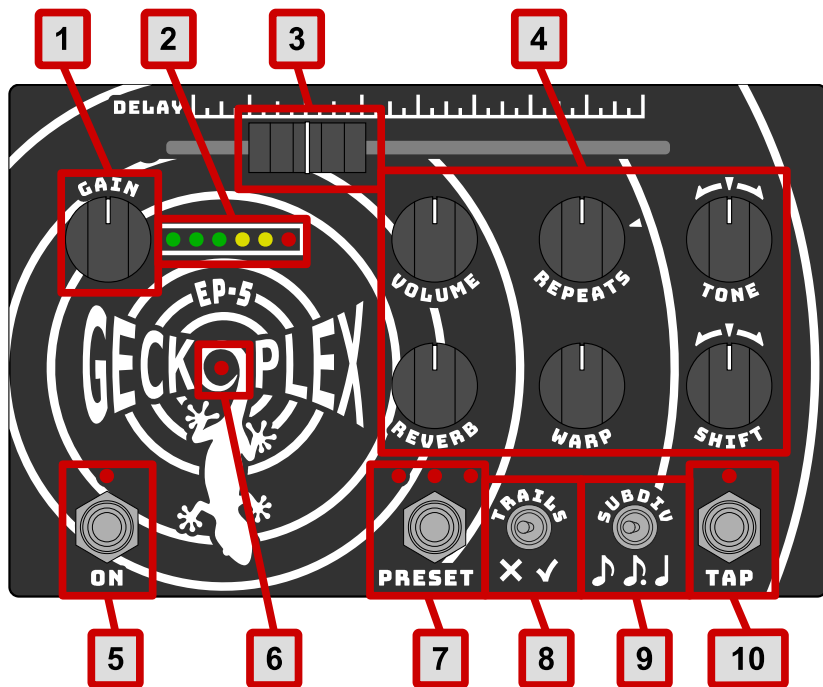



#	Description
1	DC IN is a power jack for supplying DC power from an AC/DC adapter. Be careful that the polarity is correct (barrel center is negative, sleeve is positive), and that the adapter can supply 9-12V and at least 300mA.
2	TAP is a switch jack for optionally connecting an external tap tempo switch. This jack requires an external momentary switch box and a standard mono guitar cable to connect it.
3	EXP is a jack for optionally connecting an external expression pedal. This pedal can then be used for real-time control of the effect settings. Requires a stereo guitar cable (TRS – Tip/Ring/Sleeve cable) and a compatible expression pedal.
4	IN is the input jack is for connecting input signal from an instrument (guitar, keyboard, microphone, output from another pedal, etc.)
5	OUT WET is a jack for connecting the wet output to other equipment, such as an amp, recorder, or mixer. This is a mix of the dry instrument input mixed with the wet effects. This output can be made to be purely the wet effects signal only by toggling an internal switch. In a single amp mono setup, this is the output that should be used.
6	OUT DRY is the same as the OUT WET jack except the output is the dry instrument signal only, without effects. It is essentially a buffered input passthrough with preamp gain applied.

Front Panel



#	Description
1	GAIN adjusts the preamp gain of the input signal from the IN jack.
2	Level Meter displays the current audio signal level.
3	DELAY adjusts the delay time between echoes.
4	Effects Controls adjusts the effect settings.
5	ON switch toggles the effect on or off.
6	Delay Flasher flashes the current time between echoes.
7	PRESET switch toggles between presets. Hold for 4 seconds to begin programming (See the Preset Programming Page).
8	TRAILS switch toggles whether or not trailing effects are heard when the unit is switched off.
9	SUBDIV switch adjusts the tap-tempo subdivision factor.
10	TAP switch is a tap-tempo. It sets the echo delay time by tapping repeatedly at the desired tempo.

Gain and Switches

	<p>GAIN controls the analog input preamp gain. The preamp is always on even when the ON switch is toggled off in order to maintain a constant signal level. The setting can affect the echo saturation somewhat, but for the most part this control has little influence on the effects.</p> <p>The 1:1 gain position is with the knob around 11:00, or roughly pointing toward the G in GAIN. Above this point the signal will be amplified up to a maximum of +11dB. The gain should be lowered if other pedals in the chain don't function properly with a boosted signal, or if the red "peak" light on the level meter is being reached.</p>
	<p>ON toggles the effect on and off. While off, any active preset or tap tempo setting will be maintained, but no delay or reverb effects are added to the output.</p>
	<p>PRESET cycles between the three presets. Presets can be activated with the effect turned off to avoid hearing audible changes during selection. For further preset information and programming instructions, please refer to the dedicated "Presets" page of this manual.</p>
	<p>TAP is a tap tempo switch for setting the delay with foot taps. A single tap will activate it and lock the tempo to the current delay slider setting, which is useful to lock the delay prior to activating presets that would otherwise change it. Multiple taps will activate it and set the delay time to the interval between taps. Taps should be done at quarter-note intervals. A single tap while active will deactivate the tap tempo.</p> <p>Pressing and holding the TAP switch will temporarily ramp the REPEATS control up past the runaway feedback level until it is released.</p>
	<p>The SUBDIVISION toggle switch is a 3-position switch that is part of the TAP Tempo. It controls how the delay time is set relative to the tap frequency of the TAP foot switch.</p> <p> Quarter Note: The delay time is set the same as the tap rate, causing echoes to come back at quarter-note intervals.</p> <p> Dotted Eighth Note (or 3 sixteenth notes): The delay time is set to $\frac{3}{4}$ of the tap rate. This produces echoes that are one sixteenth note faster than the tap rate. When the instrument is played at eighth notes (or two notes per the tap rate), echoes will come back in-between notes played.</p> <p> Eighth Note: The delay time is set to $\frac{1}{2}$ of the tap rate. Echoes will repeat at a rate twice as fast as the taps.</p>
	<p>The TRAILS toggle switch sets whether or not trailing echoes and reverb are heard after the effect is turned off by the ON switch. When enabled, the trailing effects will gradually fade out when turned off, but no new effects will be generated from instrument input. When disabled, the trailing effects will stop immediately when turned off.</p>

Effect Control Knobs

DELAY 



The **DELAY** slider controls the time between echoes, between a minimum of 50 milliseconds at the far left, and a maximum of 2 seconds at the far right.

This control is motorized. Its position will automatically move when using the TAP Tempo switch to set the delay, and also when presets are activated and change the delay time.



VOLUME controls the output volume of the echoes. With the knob turned all the way to the left, echoes will be silenced. With the knob turned all the way to the right, the initial echo volume will be louder than the input volume.
NOTE: This does not affect the Reverb output volume. Reverb is controlled independently with its own dedicated knob.



REPEATS controls how much echoes will continue to repeat, fading more quickly the more the knob is turned to the left. The \triangle marker at about 2 O'Clock indicates the runaway feedback point, or "self-oscillation point". With the knob turned clockwise past this marker, the repeating echoes will grow in volume rather than fade.



TONE controls the Bass/Treble tone of the echoes. The $\leftarrow \triangleright$ marker indicates the center neutral point. With the knob pointing straight up, the echo sound will be unchanged. With the knob to the left of center, the echoes will sound warmer, with more bass and less treble. With the knob to the right of center, the echoes will sound brighter, with more treble and less bass.



REVERB adds a reverberation effect, making the output sound like the instrument is being played inside of an echoing chamber or large hall. This effect is controlled separately from the echoes, and a reverb-only effect is possible by turning up the **REVERB** while turning the **VOLUME** knob all the way down.



WARP controls how tape-like the sonic qualities of the echoes are. With the knob turned all the way down to the left, echoes will sound clean and pristine, able to repeat nearly endlessly without changing much. With the knob between 9:00 and the midpoint, echoes will have the sonic qualities of those produced by a well-tuned tape machine, with each new echo blooming into a more "washed-out" sound. With the knob up past the midpoint, the echoes will begin sounding as they would sound coming from a tape machine in need of a tune-up, being more wavering, fluttering, and gritty,



SHIFT controls how much delay "shift" is applied when a note is played. This unique effect mimics the user shifting the delay slider back and forth at the same time that a note is played, causing the echoes to "shift" in pitch down and back up, or up and back down, depending on the knob direction. The $\leftarrow \triangleright$ marker indicates the center neutral point where no shift occurs. How far the knob is moved away from center determines how much the delay is shifted left or right when a note is played.

Presets

The Geckplex EP-5 has 3 fully programmable presets which can be cycled through by pressing the **PRESET** switch. The number of LEDs lit above the switch indicates which preset is currently active.

Each preset can be used with an expression pedal to make it variable. This makes it possible to control any set of controls over any desired range in real-time by simple pedal adjustments. To achieve this, two sets of control positions are stored during programming: one for the expression pedal **heel side** and one for the **toe side**.

Presets do not require an expression pedal to be used. When no expression pedal is plugged in, the preset will operate in “fixed” mode, with only the **heel side** settings being used.

Expression Pedal Compatibility:

Any compatible expression pedal will require the use of a stereo cable. This is sometimes also called a TRS cable, referring to the three Tip, Ring, and Sleeve conductors on the connector.

The Geckplex should be compatible with any **passive** expression pedal wired so that the signal comes in on the tip conductor of the cable. Any pedals from BOSS, Dunlop, Moog, or Roland should work. The Mission Engineering EP-1 and SP-1 pedals are also compatible.

Pedals wired any other way are incompatible and should be avoided. Pedals from Behringer, Korg, and Zoom are all incompatible. Wah and volume pedals that use a mono cable are also incompatible.

Expression Pedal Positions:

This manual refers to the **toe side** and **heel side** positions of an expression pedal. These are the limits of the pedal on either end. The **heel side** position is all the way back, while the **toe side** is all the way forward:

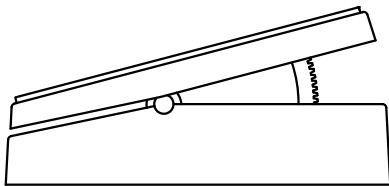

Heel Side position

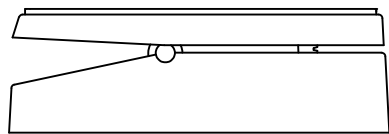

Toe Side position

Preset Programming

This page describes the procedure for programming a preset.

Important Notes:

- Programming does not require an expression pedal to be plugged in, and if one is it will not affect the the programming process in any way.
- The input **GAIN** knob and toggle switches are not controlled by presets. The positions for these controls will not be stored or controlled by a preset.

Switches in Programming Mode:

All of the foot switches have an alternate function during preset programming. These functions are as follows:

- **ON** will **CANCEL** programming mode and leave the preset unchanged.
- **PRESET** will **STORE** the settings in steps 4 and 6.
- **TAP** will **SKIP** storing the settings in steps 4 and 6, leaving that side of the settings as they were. This is very useful when re-programming a preset to fine-tune it at just one end of the expression pedal, allowing changes to be made without moving the controls twice.

Programming Steps:

Follow the steps in the table below to program a preset.

Step	Action
1	Activate the preset to be programmed using the PRESET switch.
2	Press and hold the PRESET switch for 4 seconds to enter programming mode. The active preset LED will begin to flash.
3	Set the effect knobs and the delay slider to the desired settings for this preset. Note that if an expression pedal is used, these initial settings will be for the heel side position of the expression pedal. Otherwise, without an expression pedal, these will be the fixed-mode settings used when the preset is activated.
4	Press the PRESET switch to store the first set of control settings. The active preset LED will now begin flashing twice.
5	If an expression pedal will never be used with this preset, skip to STEP 6 , as there is no need to store another set of control positions. Otherwise, set the effect knobs and the delay slider to their desired positions for the toe side of the expression pedal and proceed to STEP 6 .
6	Press the PRESET switch again to store the preset to memory and exit programming mode. The active preset LED will flash quickly for one second to indicate that the preset has been stored, followed by a return to normal operation with the newly programmed preset activated.





Sound on Sound

The Geckoplex includes a **Sound on Sound (SOS)** mode that allows looping playback of up to 40 seconds of recorded audio.

Overview:

- Press and hold the **ON** switch for 2 seconds to toggle in or out of SOS mode.
- Press **PRESET** to start recording. Press it again to stop and begin playback.
- Press **TAP** to toggle overdub. While on, any new input is added to the loop.
- During loop playback, press **ON** to pause or unpauses playback.
- The **TRAILS** and **SUBDIV** switches control the playback direction and speed.
- An expression pedal will control the loop volume if one is connected.
- The **REVERB** control is independent. Reverb effects are added after playback instead of being recorded to the loop.

Switches in Sound on Sound Mode:

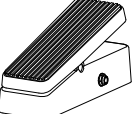
 <p>ON</p>	<ul style="list-style-type: none">• With the unit on, hold for 2 seconds to toggle SOS mode on or off.• A fast double-press will disable SOS mode and toggle the unit fully off.• During loop playback, press to PAUSE or UNPAUSE playback. The LED will pulse slowly when unpaused and quickly when paused.
 <p>PRESET</p>	<ul style="list-style-type: none">• Press to START recording a loop. The LEDs will flash quickly together.• Press again to STOP recording and begin playback. The LEDs will pulse slowly in a wave to indicate loop playback.• Another press during loop playback will abandon the current loop and immediately START recording a new loop.• Press and hold for 2 seconds to CLEAR the current loop and reset.
 <p>TAP</p>	<ul style="list-style-type: none">• Press to toggle OVERDUB recording on or off.• When enabled, any new input will be added to the loop, and the loop will degrade with typical tape characteristic effects (warble, flutter, volume loss, frequency loss, etc.) gradually fading completely away. The amount of degradation will vary with the WARP control position.• When disabled, the LED will be off. New input will not be added to the loop, and the original loop will repeat endlessly without degradation.
 <p>TRAILS</p>	<ul style="list-style-type: none">• Controls the loop playback DIRECTION.• With the switch to the right, the loop will playback normally (forward).• With the switch to the left, the loop will playback backward (reversed).
 <p>SUBDIV</p>	<ul style="list-style-type: none">• Controls the loop playback SPEED.• With the switch to the left, the loop will playback at half speed.• With the switch in the middle, the loop will playback at normal speed.• With the switch to the right, the loop will playback at double speed.
	<ul style="list-style-type: none">• If an expression pedal is connected, it will control the loop VOLUME during playback. If not, the loop will always play at full volume.• At the heel side, the loop will be muted.• At the toe side, the loop will play at full volume.

Advanced Configuration

The Geckplex allows certain settings and functionality to be configured through startup menus. Startup menu functions include:

- Resetting back to factory default settings.
- Setting the max delay time.
- Setting the expression pedal function in SOS mode.

Overview:

Enter the startup menus by holding down certain switches during power-on.

- **ON** to change the max delay time and output buffer mode.
- **TAP** to change the SOS expression pedal function.
- **ON + TAP + PRESET** to restore the unit to default settings.

Then, adjust the desired settings using **PRESET** and **TAP** switches.

Finally, press the **ON** switch to save the settings and reset.

Restore All to Factory Default Settings

First

Then

Hold At Startup

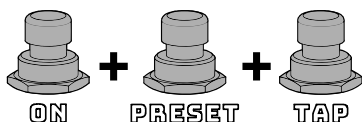

All settings are restored to their original factory default settings. This includes all presets. All LEDs will quickly flash to indicate that the defaults are restored.

Max Delay Time

First

Then

Hold At Startup



The **PRESET** switch selects the maximum delay time as follows:

- **LED 1 on** – 650 ms max (same as EP tape machines)
- **LED 2 on** – 1 second max (default)
- **LED 3 on** – 2 seconds max

The **ON** switch stores the new settings and resets the unit.

Expression Pedal Function in SOS Mode

First

Then

Hold At Startup

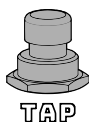

The **PRESET** switch selects the expression pedal function in SOS mode:

- **1 LED on** – Pedal controls the loop playback volume (default).
- **2 LEDs on** – Pedal controls the loop playback speed.
- **3 LEDs on** – Pedal controls the loop degradation speed.

The **ON** switch stores the new settings and resets the unit.

Example Settings

Slapback

A single echo will be heard for each note played. With very short delay times this produces a thicker chorus-like sound. With longer delay times this can double each note, giving the impression that it was played twice.

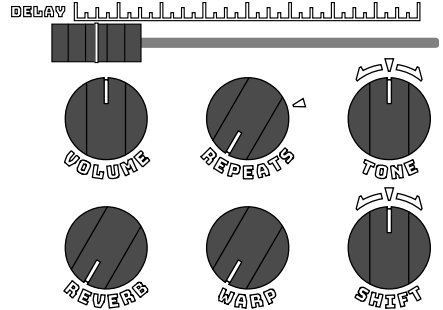

Spacious Ambiance

Reverb combined with very fast echoes (delay slider all the way to the left) produce the spacious sound of a large, reverberant, echoing room.

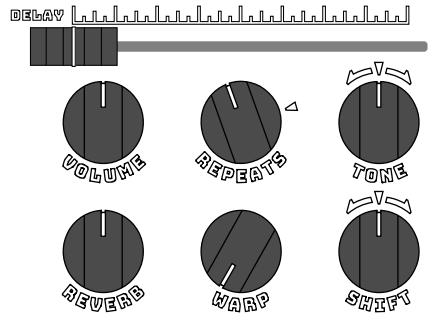

Warm Vintage Tape Echo

With the **TONE** control toward the bass side, the echoes sound warm and lo-fi. With the **WARP** control up half way, a touch of tape wavering, fluttering, and dirt are added in for a detuned vintage sound.

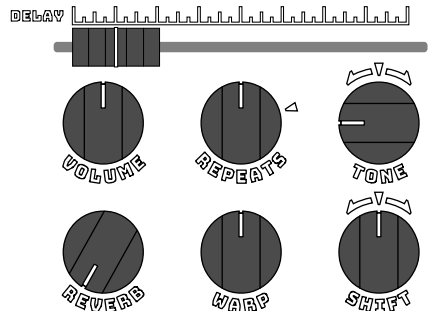

The Mothership Landing

This is a pure science-fiction alien dreamscape. Lots of **REVERB** creates a spacious feel. High **REPEATS** and **SHIFT** create almost never-ending twisted echoes trailing off into the treble end of the **TONE** spectrum.

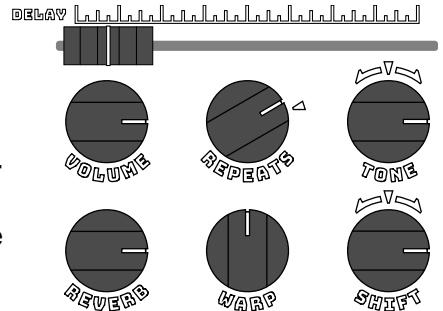

Troubleshooting

Issue	Solution
Unit does not power on	<ul style="list-style-type: none">• Ensure that the power supply has center negative polarity and can supply at least 300mA of current at 9-12V.• Check that the outlet or power strip that the supply is plugged into is live.• Try a second power supply to ensure that the first is not faulty.
Presets do not set the delay time as expected when activated	Ensure that the tap tempo is disabled. An active tap-tempo will always override the preset delay setting.
No effects are heard at the output, only the instrument sound.	<ul style="list-style-type: none">• Ensure that the unit is enabled and that the light is on above the ON switch. No effects are heard while disabled.• Ensure the output cable is plugged into the OUT WET jack. If the OUT DRY jack is used instead only the dry signal with no effects added will be heard.
No output sound	<ul style="list-style-type: none">• Ensure that the output cable is fully plugged into one of the OUT jacks.• Ensure that the GAIN knob is turned up high enough to provide useful volume.• Ensure that there is not a wiring problem with signal coming from the instrument or other upstream equipment.• Ensure that all other downstream equipment and amps are turned on and functioning correctly.
Loop playback is not heard in Sound on Sound mode	If an expression pedal is connected, it will control the loop volume in SOS mode. Ensure that the expression pedal is not muting the loop.
User becomes speechless or enters an unresponsive state of amazement	Sit down, maybe grab a cold beverage, and focus on breathing as the full magnificence of the Geckplex settles in. Also, congratulate yourself for reading all the way to the end of this manual.



geckopedals.com